

SPECIFICATIONS FOR T28 SERIES

WHITE LED

Model: 2835

Part No: T28xxx11x-Rxxxxx

Features:

- * Top view white LED
- * Thermally Enhanced Package Design
- * High luminous flux output
- * High current capability
- * Compact Package Size
- * Wide viewing angle
- * Pb-free Reflow Soldering Application
- * The product itself will remain within RoHS compliant version



Applications

- * Interior lighting
- * Retrofits (replacement)
- * General lighting
- * Architectural / Decorative lighting

Part Numbering System

T -

X1 X2 X3 X4 X5 X6 X7 X8 X9 X10

Item Number Code	Description	Content
X1	Type code	1S:1010; 1A:1919; 20:2016; 3B:3014; 28:2835 34:3020; 3C:3030; 5C:5050; 7C:7070; 1D:100100; 19: Ceramic 3535; 15: Ceramic 5050; 11: Ceramic 1616.
X2	CCT code	2700K:27; 3000K:30; 4000K:40; 5000K:50; 5700K:57; 6500K:65.
X3	Color Rendering	Ra70:7; Ra80:8; Ra90:9.
X4	No. of serial chip	1-Z.
X5	No. of parallel chip	1-Z.
X6	Component code	A-Z.
X7	Color Code	M:ANSI; F:ERP; R:85°C ANSI; T:105°C ANSI; B:Backlighting; Q:Others;
X8	Internal code1	\
X9	Internal code2	\
X10	Spare code	\

Electro Optical Characteristics, IF =150mA

CCT	Color Rendering	Luminous Flux	
		T _j =25°C	
	Min.	Typ.	Min.
2700K	70	65	60
	80	62	55
	90	52	45
3000K	70	68	60
	80	65	60
	90	54	50
4000K	70	71	65
	80	68	60
	90	56	50
5000K	70	71	65
	80	68	60
	90	56	50
5700K	70	71	65
	80	68	60
	90	56	50
6500K	70	71	65
	80	68	60
	90	56	50

* Tolerance of measurements of the Luminous Flux is $\pm 7\%$.

* Ra measurement tolerance is ± 2 .

* Correlated Color Temperature is derived from the CIE 1931 Chromaticity diagram.

Absolute Maximum Ratings at Tj=25°C

Item	Symbol	Absolute Maximum Rating	Unit
Forward current	I _F	200	mA
Pulse Forward current	I _{FP}	240	mA
Power Dissipation	P _D	660	mW
Reverse Voltage	V _R	5	V
Operating Temperature	Topr	-40~+85	°C
Storage Temperature	Tstg	-40~+100	°C
Junction Temperature	Tj	120	°C
Soldering Temperature	Tsld	Reflow Soldering: 230°C or 260°C for 10sec	

* I_{FP} condition with Pulse: Width≤100μs, Duty cycle≤1/10.

* LED's properties might be different from suggested values like above and below tables if operation condition will be exceeded our parameter range. Care is to be taken that power dissipation does not exceed the absolute maximum rating of the product.

* All measurements were made under the standardized environment of Lightning LED.

Electrical/Optical Characteristics at Tj=25°C

Item	Symbol	Min	Typ	Max	Unit	Condition
Forward Voltage	V _F	2.7	-	3.3	V	IF=150mA
Reverse Current	I _R	-	-	10	μA	VR=5V
Luminous Flux	Φ _V	45	68		lm	IF=150mA
View Angle	2θ _{1/2}	-	120	-	°	IF=150mA
Correlated Color Temperature	CCT	2700	4000	6500	K	IF=150mA
Color Rendering Index	Ra	70	80		-	IF=150mA
Color Rendering Index	R9	-	-	-	-	IF=150mA
Characteristics Coordinates	X	-	0.3875	-	-	IF=150mA
	y	-	0.3868	-	-	IF=150mA
Thermal resistance	(R _{th j-sp})	-	26	-	°C/W	IF=150mA
Electrostatic Discharge	ESD	1000	-	-	V	HBM

* Tolerance of measurements of the Forward Voltage is ±0.1V.

* Tolerance of measurements of the Luminous Flux is ±7%.

* 2θ_{1/2} is the off-axis where the luminous intensity is 1/2 of the peak intensity.

* Correlated Color Temperature is derived from the CIE 1931 Chromaticity diagram.

* Ra measurement tolerance is ±2.

* R9 measurement tolerance is ±6.5.

* Tolerance of measurements of the chromaticity Coordinate is ±0.005.

* R_{th j-sp} is the thermal resistance from LED junction to solder point on MCPCB with electrical power.

Bin Structure

Luminous Flux Ranks, IF = 150mA, Tj =25°C

CCT	Color Rendering		Luminous Flux		
	Min.	Typ.	Code	Min	Max
2700K	70	72	1S	60	65
			1T	65	70
			1W	70	75
	80	82	1R	55	60
			1S	60	65
			1T	65	70
	90	92	1P	45	50
			1Q	50	55
			1R	55	60
3000K	70	72	1S	60	65
			1T	65	70
			1W	70	75
	80	82	1S	60	65
			1T	65	70
			1W	70	75
	90	92	1Q	50	55
			1R	55	60
			1S	60	65
4000K	70	72	1T	65	70
			1W	70	75
			1X	75	80
5000K	80	82	1S	60	65
			1T	65	70
			1W	70	75
5700K	80	82	1Q	50	55
			1R	55	60
			1S	60	65
6500K	90	92	1R	55	60
			1S	60	65

* Tolerance of measurements of the Luminous Flux is $\pm 7\%$.

* Ra measurement tolerance is ± 2 .

Forward Voltage Ranks, $I_F = 150\text{mA}$, $T_j = 25^\circ\text{C}$

Code	Min	Max	Unit
A1	2.7	2.8	V
B1	2.8	2.9	V
C1	2.9	3.0	V
D1	3.0	3.1	V
E1	3.1	3.2	V
F1	3.2	3.3	V

* Tolerance of measurements of the Forward Voltage is $\pm 0.1\text{V}$.

CIE Chromaticity Diagram, $I_F = 150\text{mA}$, $T_j = 25^\circ\text{C}$

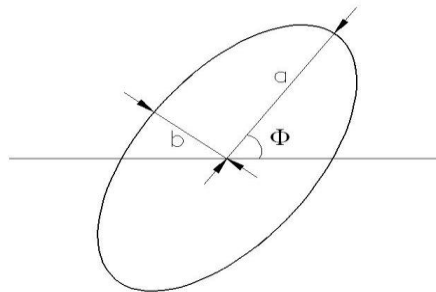

The color ranks have chromaticity ranges within 5-step MacAdam ellipse

Color Code	Center		Radius		Angle(deg)
	x	y	a	b	Φ
27R5	0.4620	0.4145	0.013500	0.00700	53.42
30R5	0.4383	0.4081	0.013900	0.00680	53.13
40R5	0.3875	0.3868	0.015650	0.00670	53.43
50R5	0.3507	0.3635	0.013700	0.00590	59.37
57R5	0.3348	0.3491	0.011175	0.00550	58.35
65R5	0.3187	0.3363	0.011150	0.00475	58.34

* Energy Star binning applied to all 2600~7000K.

* Tolerance of measurements of the chromaticity Coordinate is ± 0.005 .

Fig 1. Color Spectrum, $T_j = 25^\circ\text{C}$

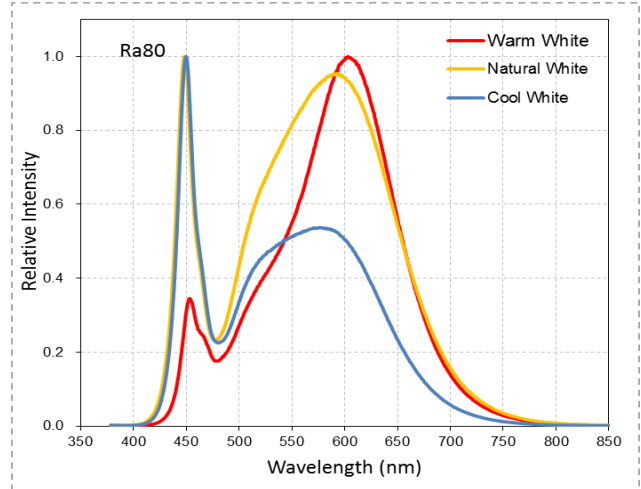
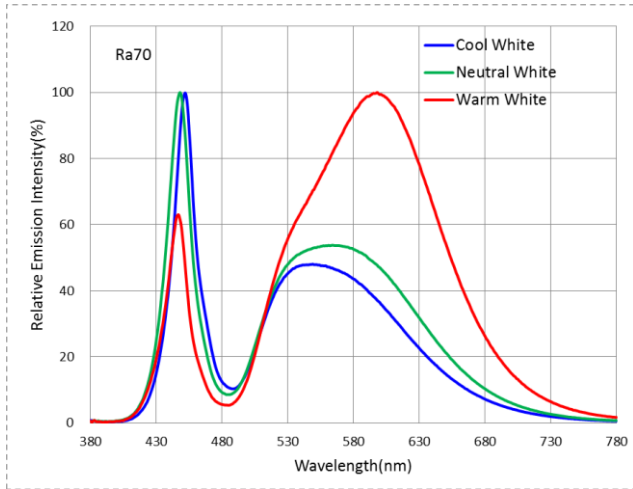

Fig 2. Viewing Angle Distribution, $T_j = 25^\circ\text{C}$

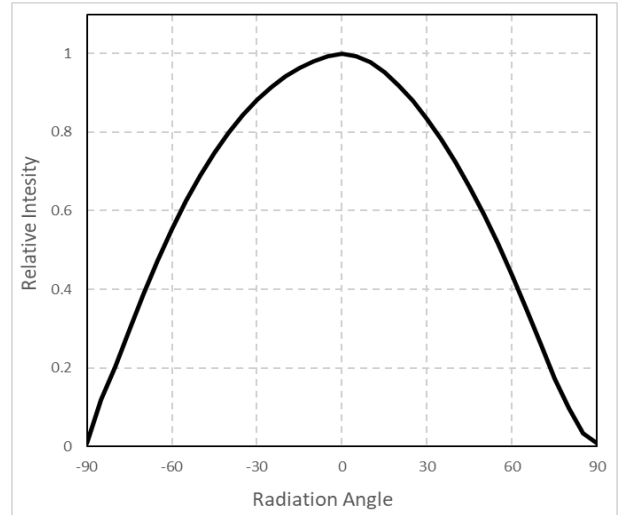
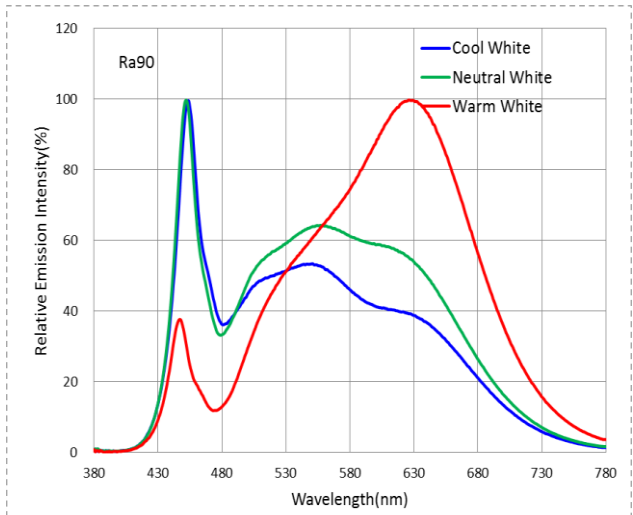

Fig 3. Forward Current vs. Relative Intensity, $T_j = 25^\circ\text{C}$

Fig 4. Forward Current vs. Forward Voltage, $T_j = 25^\circ\text{C}$

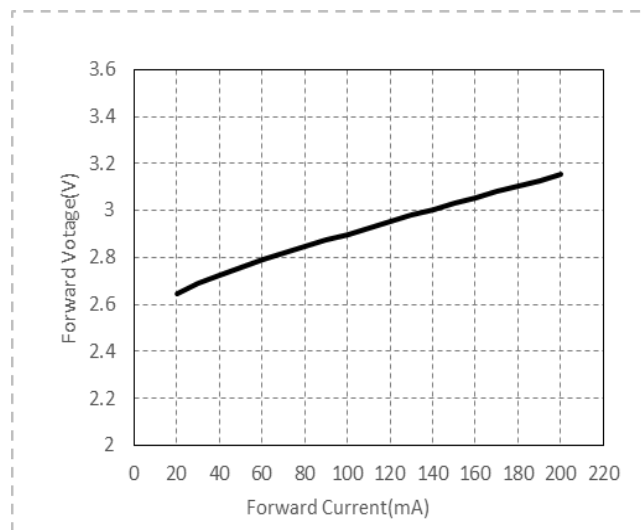
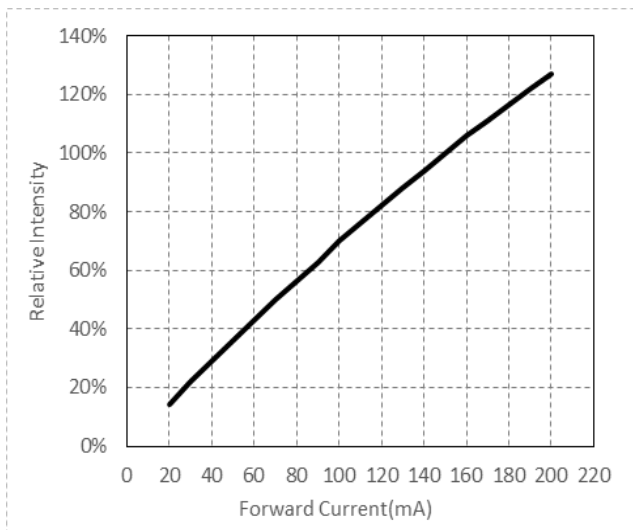

Fig 5. Surface Temperature vs. Relative Luminous flux (IF=150mA)

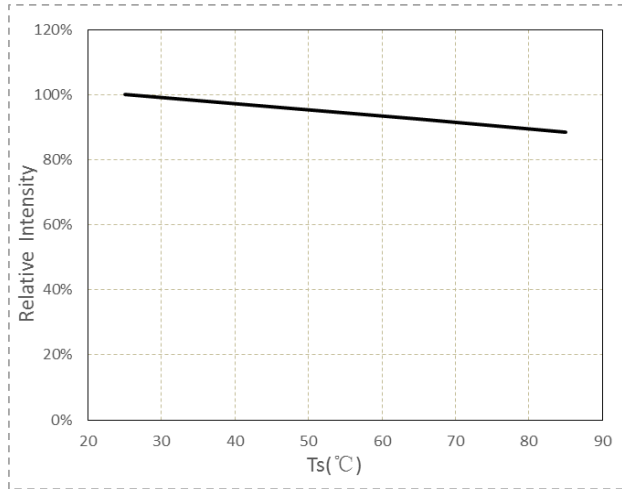

Fig 6. Surface Temperature vs. Relative Forward Voltage (IF=150mA)

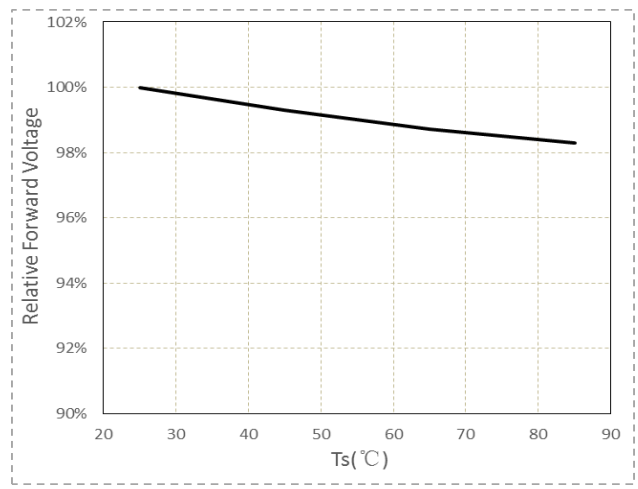
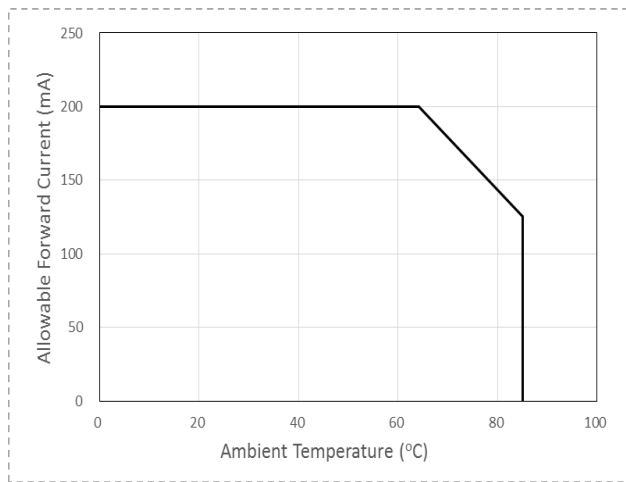
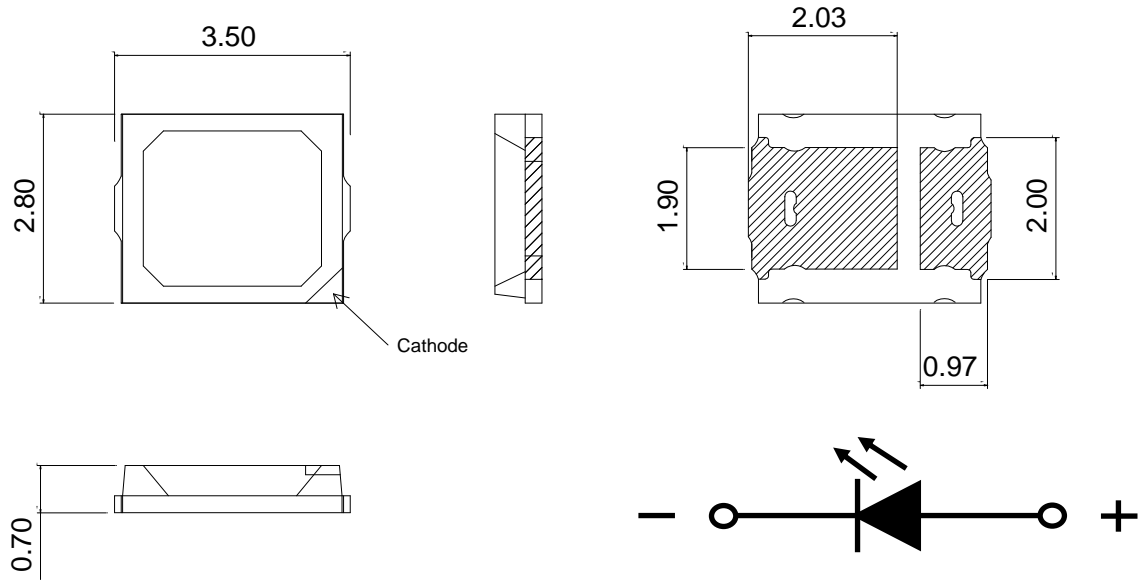

Fig 7. Allowable Forward Current vs. Ambient Temperature



Package Dimensions



* The tolerance unless mentioned is $\pm 0.1\text{mm}$, unit = mm

Reflow Soldering Characteristics

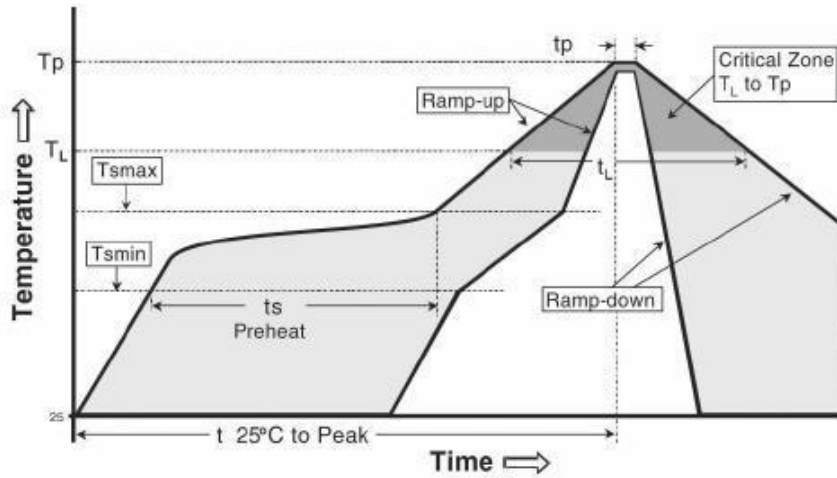

Reflow soldering	
Temperature Min (T Amin)	150° C
Temperature Max (Tsmax)	200° C
Time(ts)from (T Amin to Tsmax)	60-120 seconds.
Ramp-up rate (TL to Tp)	3° C/seconds max.
Liquidous temperature(TL)	217° C
Time(tL) maintained above TL	60-150 seconds
Peak package body temperature(Tp)	260° C max
Time (tp) within 5° C of the specified classification temperature (Tc).	30 seconds max
Ramp-down rate (Tp to TL)	6° C/second max
Time 25 ° C to peak temperature	8 min max

Package Dimensions of Tape

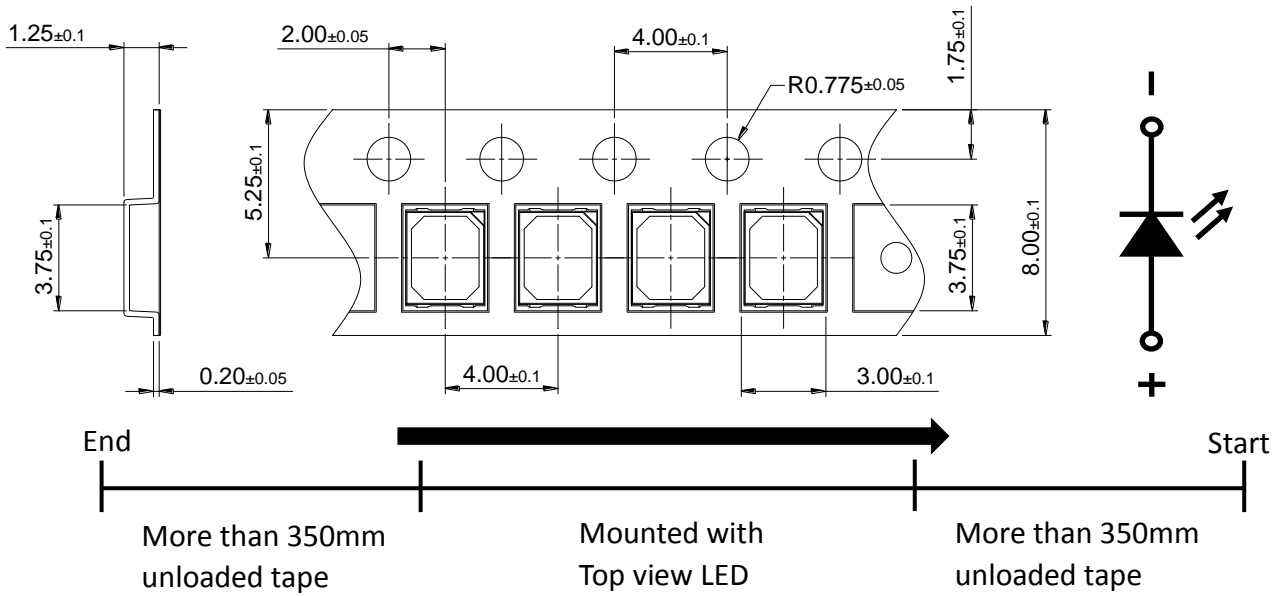

- * Quantity : Max 18000pcs/Reel
- * Cumulative Tolerance : Cumulative Tolerance/10 pitches to be ± 0.2 mm
- * Package : P/N, Manufacturing data Code No. and Quantity to be indicated on a damp proof Package.
- * unit = mm

Package Dimensions of Reel

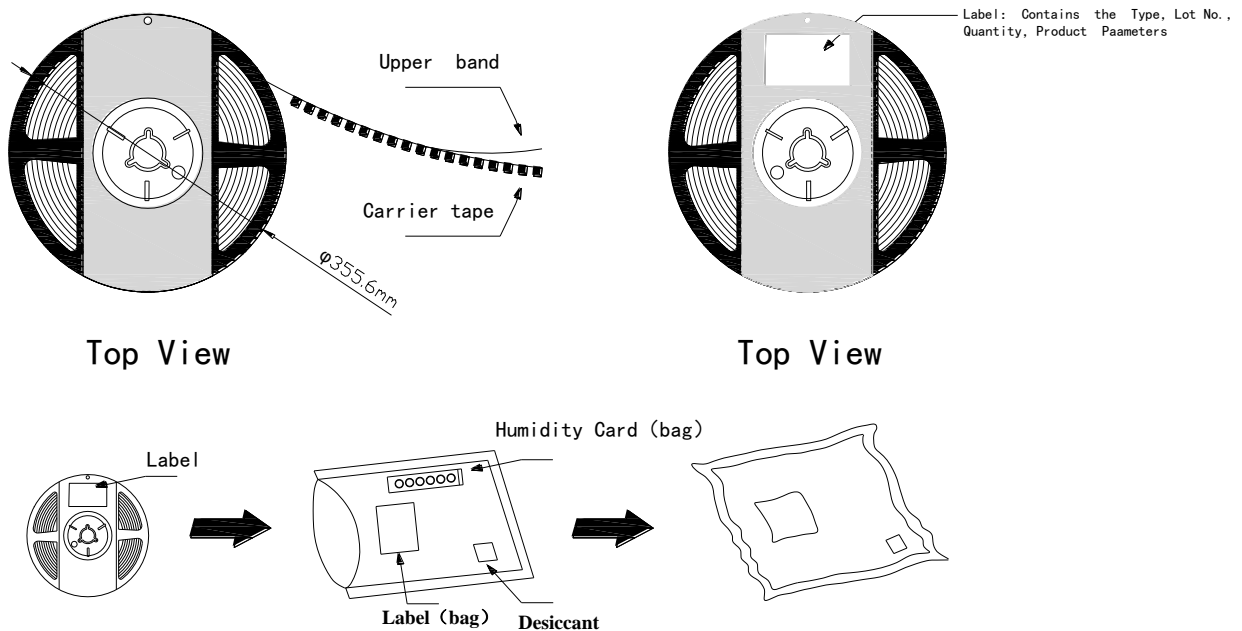

Package Box

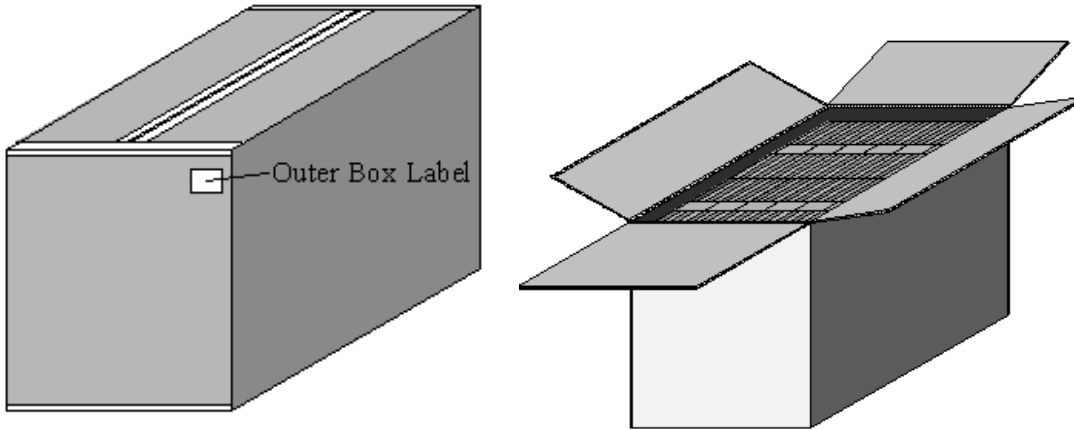

Label

- Capacity 10 reels per box (外箱容量: 10 卷)

福建天电光电有限公司

FUJIAN LIGHTNING OPTOELECTRONIC CO.LTD

型号Type: T*****_*****



光通量 Φ @ *** mA: *** - *** [LM]

色区Color Bin@*** mA: ****

电压 V_f @ *** mA: ** - ** [V]

显指 R_a @ *** mA: ** (MIN)

Lot No.: A*****_*_ *****

Bin Code: ****

数量QTY:**** PCS



Caution

1. Reflow soldering is recommended not to be done more than two times. In the case of more than 24 hours passed soldering after first, LEDs will be damaged.
2. Repairs should not be done after the LEDs have been soldered. When repair is unavoidable, suitable tools must be used.
3. Die slug is to be soldered.
4. When soldering, do not put stress on the LEDs during heating.
5. After soldering, do not warp the circuit board.

Notes on Lightning PCT Series soldering:

1. Recommend to use reflow machine.
2. Recommend to use heating plate soldering.
3. Manual soldering is not recommended.

Notes on reflow process:

1. To confirm whether the actual temperature curve in the reflow soldering conditions comply with recommended conditions. LEDs are guaranteed for one time reflow.
2. During reflow process do not apply force on LED active area.
3. After reflow process, PCB board should be cooled down before packing or storage.

Precaution for use

Storage

1. Before opening the package: The LED should be kept at 30°C or less and 90%RH or less.
2. After opening the package: The LED's floor life is 168Hrs under 30°C or less and 60%RH or less. If unused LED remain, it should be stored in moisture proof packages JEDEC (MSL 3).
3. If the moisture absorbent material (silica gel) has faded away or the LEDs have exceeded the storage time, baking treatment should be performed using the following conditions:
Baking treatment: 60±5°C for 24 hours.